

# V MOUNT ADAPTER FOR LX-1000

## Application

1918070000 TZ-LXVMK16 VMOUNT ADAPTER  
1918070010 TZ-LXVMK32 VMOUNT ADAPTER  
1918070020 TZ-LXVMK48 VMOUNT ADAPTER

SCREW (M4\*10 HEXAGONAL SOCKET HEAD)  
\*Tightening torque : 90 N · cm (9 kgf · cm)

16ch model  
TZ-LXVMK16

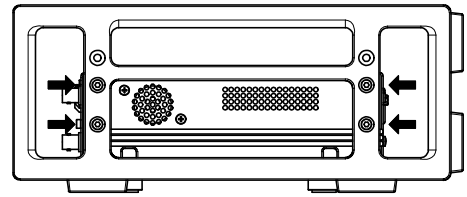
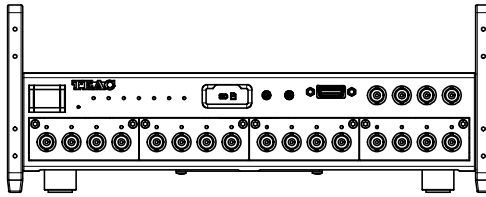

32ch model  
TZ-LXVMK32

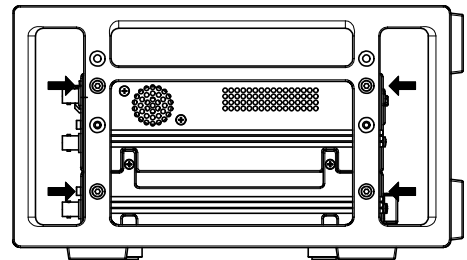
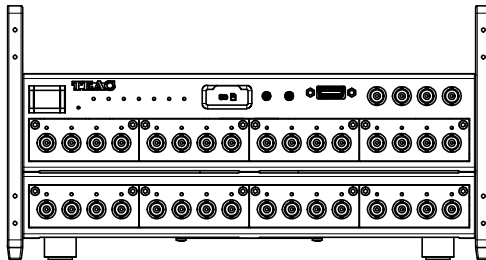

48ch model  
TZ-LXVMK48

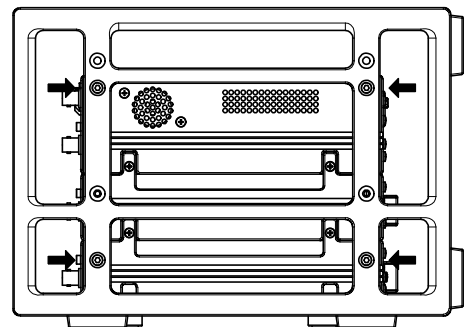
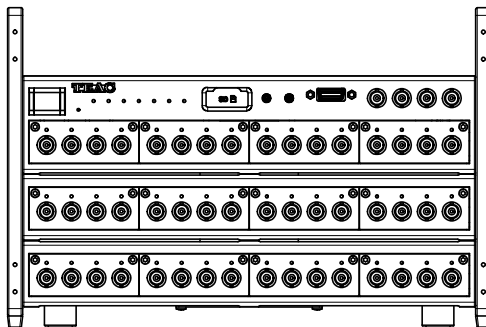

64ch model

TZ-LXVMK16 × 2

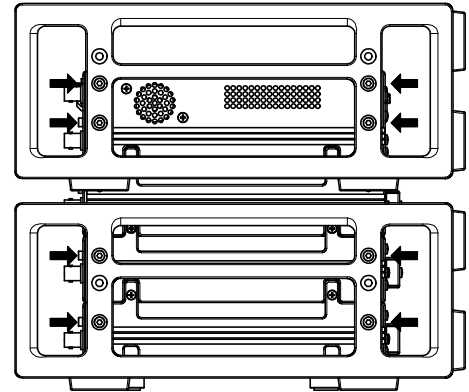
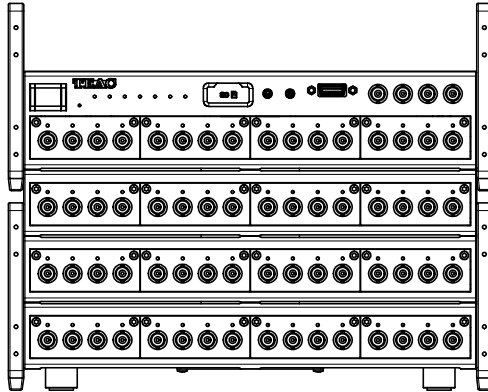

64ch model+1BU

TZ-LXVMK16  
TZ-LXVMK32

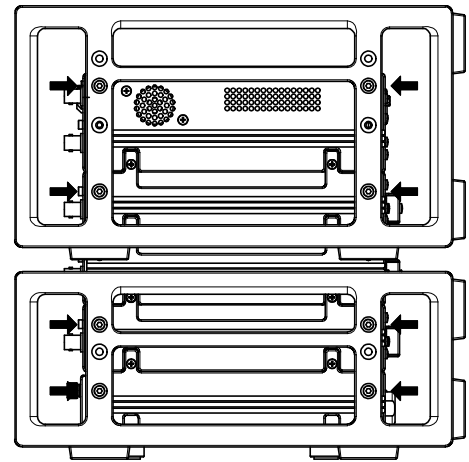
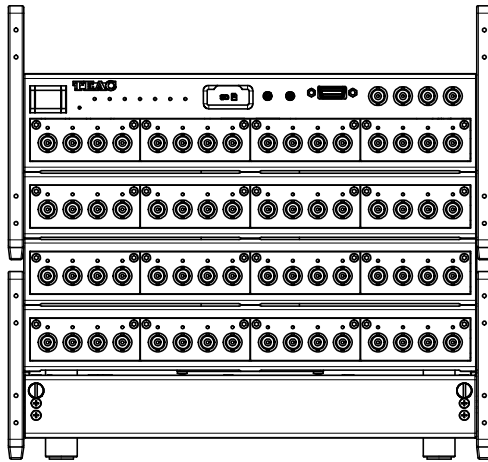

64ch model+2BU

TZ-LXVMK32 × 2

